



# ETS

## FIXATION INDUSTRIELLE

[www.ets-internationale.fr](http://www.ets-internationale.fr)

France

Tunisie

[www.ets-tunisia.com](http://www.ets-tunisia.com)

**Tunisie** : 3 , Rue Salah Ibn Youssef , Magasin N:3 , Résidence Jughura 2046 Sidi Daoued  
Tél : +216 71 777 370 - 71 777 842 / Fax : 71 777 344 / Mail : [contact@ets-tunisia.com](mailto:contact@ets-tunisia.com)

**France** : 75 , Rue de Fontenay 94300 Vincennes - France  
Tél : +33 78272494 / Mobile : +33782724925 / Mail : [contact@ets-international.fr](mailto:contact@ets-international.fr)



---

FIXATION INDUSTRIELLE

---

**France** : 75 , Rue de Fontenay 94300 Vincennes - France

Tél : +33 178541920 / Mobile : +33782724925 / Mail : [contact@ets-international.fr](mailto:contact@ets-international.fr)

**Tunisie** : 3 , Rue Salah Ibn Youssef , Magasin N:3 , Résidence Jughura 2046 Sidi Daoued

Tél : +216 71 777 370 - 71 777 842 / Fax : 71 777 344 / Mail : [contact@ets-tunisia.com](mailto:contact@ets-tunisia.com)

**Magazin Tunis** : 20 Rue Ahmed Tlil 1001 Tunis

Tél : +216 71 335 549 / Mail : [contact@ets-tunisia.com](mailto:contact@ets-tunisia.com)

---



## NOTRE HISTOIRE

Des associés franco-Tunisiens, ayant travaillé pour les plus grandes industries internationales, décident de créer la société ETS TUNISIA en 2009 pour se spécialiser dans la fixation industrielle et ouvrent un premier magasin à Sidi daoued La Marsa. Depuis l'entreprise ne cesse de se développer et élargir sa gamme de produits pour toucher tous les secteurs d'activité et répondre au x besoin de toutes les industries.

En 2019, ETS FRANCE est née et s'installe au 94300 Vincennes-France pour servir le marché européen et servir de base logistique pour atteindre aussi le marché africain

En 2020, ETS TUNISIA s'installe dans un nouveau dépôt équipé de plus de 1200 mètres carrés et devient une véritable entreprise, un point de référence dans la fixation industrielle, en gagnant la confiance de moyennes et grandes entreprises du secteur industriel sur le marché national et exporte en Algérie.

## DE FOURNISSEURS A PARTENAIRES

Notre mission est de soutenir nos clients dans la réduction des frais globaux de l'approvisionnement. Pour cela l'entreprise propose et partage des solutions techniques, développe des services innovateurs qui réduisent les frais de gestion et fournissent une gamme de produits toujours plus vaste, afin de réduire le nombre de fournisseurs.

## NOTRE VISION

Notre engagement, notre passion et notre professionnalisme s'unissent pour permettre à nos clients d'oublier la gestion des pièces de classe C. Nous nous efforçons de venir un point de repère bien connu sur le marché qui est capable d'innover pour devancer les besoins







## UNE LOGISTIQUE CONSTRUITE AUTOUR DU CLIENT



Dans le cadre où il est de plus en plus important de fournir des réponses rapides aux besoins du marché, une organisation logistique efficace est essentielle pour faire face à ces attentes.

### SYSTEME KANBAN AVEC CAPTEURS DE POIDS

Le système KANBAN est un système logistique extrêmement adaptable et conçu spécifiquement pour nos clients pour détecter les produits manquants en se basant essentiellement sur une combinaison de cellules de chargement avec des capteurs de détection du poids et suggère au responsable logistique de passer les commandes pour les produits manquants. Cette option permet l'auto-alimentation des différentes lignes de production, qui demeurent de même sous le contrôle grâce à l'envoi automatique de courriels au responsable logistique, contenant toutes les informations à propos de ces articles manquants en lui demandant de confirmer ou non la commande.

## EASYSELF 24



Dans le cadre de l'industrie 4.0, le système EasySelf 24, installé dans les lignes de production, permet d'automatiser le débit de gestion complet de différents articles, parmi lesquels ; outils, gants, accessoires, équipement divers. Le système garantit l'enregistrement précis de chaque prélèvement du matériel et de l'opérateur qui l'a effectué. EasySelf 24 communique avec les principaux logiciels de gestion, gère la commande des articles au fournisseur et établit des statistiques sur les consommations, en optimisant toutes les activités liées aux règles en vigueur en matière de sécurité sur le lieu de travail.



# BOULONNERIE



Nous proposons une très vaste gamme de produits normalisés disponible en stock. Pour chaque article, nous choisissons les producteurs les plus qualifiés selon de rigoureux critères de qualité.



## PIECES SPECIALES SUR MESURE

Les partenaires importants que nous avons développés au fil des années avec nos fournisseurs nous permettent aujourd'hui de répondre aux demandes les plus variées en matière de pièces spéciales sur mesure, tout en restant compétitifs et en fournissant du matériel de qualité. Nous pouvons choisir d'utiliser des machines traditionnelles à cames mettant à profit leur prix bon marché pour la production de pièces simple, ou de passer à des tours CNC plus sophistiqués et complet si la forme et la précision des pièces l'exigent.

Nous pensons être en mesure de proposer des solutions avantageuses pour des lots importants, à l'aide de tours multibroches.



Notre expérience en matière de matériaux et de revêtement de protection s'étend désormais à tous les types les plus utilisés et répondus sur le marché.

## CONFECTION DE KIT SUR MESURE



- • Nous proposons à nos clients des produits en Kit afin de leur assurer un service sur mesure au moindre coût. Les clients peuvent demander des personnalisations, telle que ; l'application des codes-barres sur l'emballage, le logo...etc .



## CHEVILLES ET ANGRAGES



Nous disposons de chevilles et de chevilles d'encrage en tous genres, qui sont en mesure de s'acquitter de leur fonction y compris en cas de besoins de résistance et de fiabilité extrême.





# BOULONNERIE

## ACCESSOIRES POUR L'INDUSTRIE OLEODYNAMIQUE, PNEUMATIQUE ET FLUIDE



• Grace à la collaboration que nous  
• avons développée avec les plus  
• importants entreprises de secteur,  
• nous disposons d'une vaste  
• gamme de produits de très haute  
• qualité : des tuyaux souples, des  
• raccords, des adaptateurs, des  
• coupleurs rapides, des boulons à  
• crochet, des manomètres,  
• bouchons de fermeture, de rem-  
• plissage et dégazage, des indica-  
• teurs et des jauges de niveau de  
• l'huile..



## ACCESSOIRES POUR L'INDUSTRIE DE LEVAGE



• Grace à la collaboration avec d'import-  
• tants producteurs du secteur du levage  
• industriel, nous disposons d'un import-  
• ant stock d'articles de haute qualité en  
• magasin : des anneaux à tige tournants,  
• des dispositifs d'engrage et d'arrêt  
• anti-chutes, de bandes de levage...



# BOULONNERIE

## VIS ANTIVANDALISME



Grace à la collaboration avec d'importants producteurs du secteur du levage industriel, nous disposons d'un important stock d'articles de haute qualité en magasin : des anneaux à tige tournants, des dispositifs d'engrage et d'arrêt anti-chutes, de bandes de levage...



## RIVETS AVEUGLE-RIVET DE STRUCTURE ET RIVETS ETANCHE



Un amples choix de rivets aveugles standard, rivets de structures, rivets étanches, produits en différents matériaux, tels que ; l'aluminium, l'acier, le laiton, l'acier inoxydable. Gris foncé (RAL 7001), gris clair (RAL 7035), noir (RAL 9005), avec des filetages à pas PG, métrique et NPT.





## PRESSE-ETOUPE



Notre gamme de presse-étoupe en plastique et de laiton nickelé dispose de toutes les certifications, pour les clients les plus exigeants. Ces produits sont disponibles en classe d'isolation IP65/68, en trois couleurs :



## PASSE-FILS

La vaste gamme de passe-fils en PVC, EPDM, néoprène, silicone et nylon permet au client de trouver un produit de haute qualité pour les applications les plus variées.



## JOINT TORIQUE



• Au cours de ces dernières années, les partenariats avec d'importantes entreprises du secteur nous ont permis d'ajouter une vaste sélection d'éléments pour l'étanchéité statique à la ligne que nous proposons ; des joints toriques, des joints d'étanchéité, des rondelles d'étanchéité adaptées aux secteurs hydraulique, pneumatique, chimique et mécanique.

## COLLIERS DE SERRAGE

La vaste gamme de passe-fils en PVC, EPDM, néoprène, silicone et nylon permet au client de trouver un produit de haute qualité pour les applications les plus variées.



## COLLIERS SERRE-TUBE



• Dans la lignée de la qualité qui nous caractérise, nous fournissons des colliers serre-tube fabriqués pour assurer une résistance maximale, avec ou sans vis, conformément à la norme DIN 3017. Bifilaire, les colliers à tourillon pour hautes pressions et les serre-tuyaux avec fixation à vis, complètent la gamme.



## ENTRETOISES



Dans la gamme des entretoises, il existe toujours un produit qui satisfait la demande de fixation : Des entretoises en laiton nickelé, en acier inoxydable, en fer zingué, avec filetage métrique, en plastique PA66 ou en PA6, chargé fibre de verre, avec coupleur rapide, fileté à l'intérieur et à l'extérieur.



## SUPPORTS ANTIVIBRATOIRES

Un vaste choix de supports antivibratoires complète la gamme disponible.

Ces produits sont utilisés principalement dans le secteur industriel, en présence de machines qui requièrent l'atténuation des vibrations et du bruit, ou dans d'autres secteurs parmi lesquels :

Les secteurs alimentaires, marin, de la réfrigération, de la pharmacie, de la climatisation et du traitement d'air.



## ELEMENTS DE MANŒUVRE ET DE SERRAGE



- • Le vaste catalogue que nous proposons inclut les boutons de serrage, des volants, des poignées, des manivelles, de manette et bien d'autre articles.



## PIED REGALBLE EN HAUTEUR, BOUCHONS ET CACHE-VIS



Ces articles peuvent être appliqués sur un grand nombre de machine telles que : machines pour le conditionnement, outillage électronique, machines à café, mobilier de bureau.....etc





# BOULONNERIE

## ELEMENTS MECANIKES



• •  
• •  
• • Nous sommes en mesure de fournir  
• • composants mécaniques qui simplifient  
• • et améliorent l'assemblage des ma-  
• • chines.

Bagues d'arrêt DIN 705, bagues d'arrêt fendue, les poussoirs à ressort, doigts d'indexage, goupille d'arrêt, des filets rapportés permettant le réemploi / la réparation des trous filetés.

## LES ROULETTES



• •  
• •  
• • Notre gamme de roulettes couvre plusieurs secteurs : équipements médicaux, restauration, bureau, appareils ménagers.....etc  
Les roulettes sont disponibles en différents matériaux et différentes charges.

## EQUIPMENTS DE PROTECTION INDIVIDUELLE



- Visant toujours plus de service total et une extension de notre gamme, nous proposons des équipements de protection individuelle (EPI), conformément aux normes en vigueur en matière de sécurité sur le lieu de travail.





## FIXATION POUR TÔLE



- Ecou à sertir en aveugle, ouvert ou borgne pour les tôles de faibles épaisseurs avec cannelures d'ancrage ou hexagonaux. Toutes formes de têtes : plates, larges, affleurantes, fraisées.



- Goujons à sertir, colonnettes et Ser-ecrous ; acier zingué blanc, inox A2 et inox A4

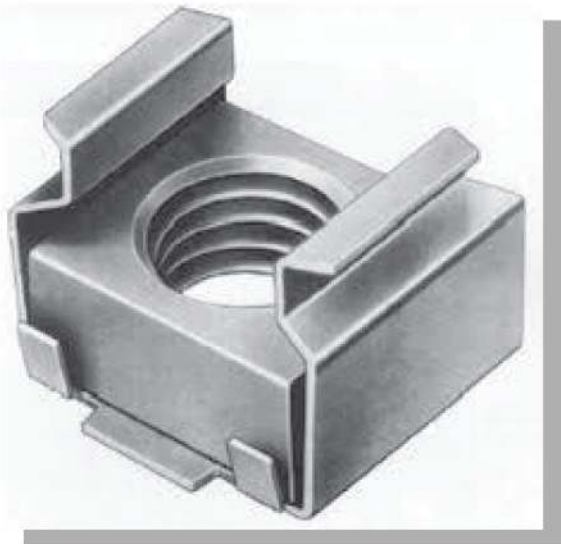

- Ecoucs cage permettant une fixation rapide dans les supports métalliques de faible épaisseur, préalablement poinçonnées.



- Goujons à souder ; en cuivre, en aluminium et en inox A2

## LES FILETS HELICOIL

Les filets rapportés HELICOIL® génèrent des taraudages haute résistance, résistants à l'usure, à la chaleur et de haute précision, dans lesquels la répartition des contraintes dans le taraudage est uniforme.



## COLONNETTES ET SERÉCROUS



## GOUPILLES





# FIXATION

## FIXATION PLASTIQUE



Inserts type douilles taraudées et goujons filetés standards pour une pose par procédé thermique, à surmouler ou à froid, dans tous types de plastiques.



Insert autotarauteur : Laiton, acier zingué, acier cémenté zingué, inox pour support : Plastiques et métaux légers.  
pas métrique : M2.5 à M8 autres dimensions sur commande

## FIXATION BOIS

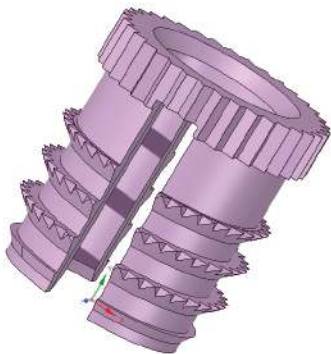

Insert à frapper par expansion fendu en laiton pour Tous types de bois pas métrique : M4 à M10



Insert autotarauteur à visser en zamak pour Tous types de bois pas métrique : M4 à M10



Ecrou à griffe

# FIXATION

## OUTILS DE POSE



● Pince à batterie pour rivets

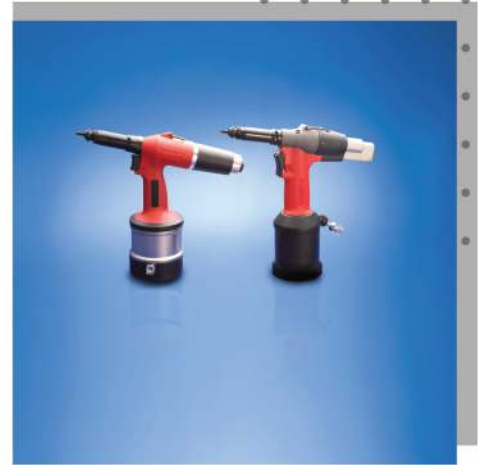

● Pince de pose oléopneumatique pour écrous à sertir



● Pince de pose oléopneumatique pour rivets



● Soudeuse de goujons



● Pince à batterie pour écrous à sertir



# FOURNITURE ET ACCESSOIRES POUR SECTEUR ELECTRIQUE ET ELECTRONIQUE

● Nous vous proposons une large gamme de fourniture ; serrures industrielles, charnières, joints et autres solution innovantes à tous les types de boîtiers électriques, industrie mécanique, générateurs, boîtes de distribution, automobile et meubles.





001-1



001-ok



002



002-1



002-asma kilit



003 ok



003-1



004



004-asma kilit



005



005-1



006



007-1



007-5



007-A



007-Asmali



007-asmali



007-B



008



008-1



009



009-1



010



010-1



010-Asmali





o11



o12-V1



o12-V3



o13-V1



o13-V3



o16-Asma Hamilli



o16-1



o17



o17-1



o17-Asma Hamilli



o18-1



o18-Asma Hamilli



o20



o21



o22



o24



o25



o30-V1



o30-V2



o40



o50



o50-a



o51



o51-a



101-3  
Anahtarli



101-4,1480



101-V  
Anahtarli



101-V2



101-V3  
Anahtarli



103



105



105-1



106-V1



106-V2



106-V4



106-V5



106-V6



107



108



108-30  
Duz mansalli  
Segmanli



108-30  
Duz mansalli



108-30-Sac



109



111



112



113 Y



114 Yeni





115  
Kilitli



120



121  
Anahtarli



123  
Anahtarli



124  
Anahtarli



126



127



128



130



133



135



136



137



137-1



138



139



200,1



200-1



201-DB



201-Kare



200-P DB



201-pg



204-50



201PG-Simm db



201PG-7mm kare



201PG-9mm üçgen



201SS,11 Anahtarli



201-üçgen



203-1,k2



203-1,k4



203-1,k9



203-2,k1



203-2,k3



203-2,k7



203-3



203-4



203-5  
5mm db



203-5  
8mm Kare



203-5  
9mm üçgen



203-6



203-6k12-  
8mm allen



203-9-  
paslanmaz



203-K2



203-K4



203-K9



204





20455



205



206  
Asma kilitli



206



207A



207-V1  
cubuk



207-V1



207-V2  
cubuk



207-V2



207-V3



207-V4



207-V5



207-V6



208  
Asma kilitli



208



208-1



209A



209A-V2



4115628



705492



209LKY V1



209LKY



209-V1



209-V2



209-V3



210



210-1



211



211A



212 sag



212-sol



213-135



213-202



213-290



214



215



216-  
9mm uçgen



217



207-V6



208  
Asma kilitli



208



221-A



222



223



224



225



226





230



230-V2



231-1



231-siyah



232



232-  
Boyali Anahtarli



232-Nüve



232SS



233SS



233-50



234-50



236



236-Boyali



237-DB



237SS.10



237  
Tornavida



237  
uçgen



238



239-  
50mm



241



242  
Anahtarli



244  
Anahtarli



245



246



247



248.379



248



249



250



252  
Karsilik sacii



252



253



252



255



255-50



255-V1



256



256-V1



257



257-1333



257-DB



257  
Kare



257  
üçgen



257-V1



257-V2



257-V3



257-V4



257-V5



258



258-1333



258-db



258-V1



258-V2



258-V3



258-V4



260



261



261



261-1



262



262,457



262



26555



266



267



269-V2



270



270-V1



271



272SS



273



285



286



300-1



300-1SS



300-4  
V1



300-4  
V2



300-V1





300-V1



300-V2



301



302



303



306



307



308ss



308-V1



308-V2



308-V3



308-V4



309



310 Crom



310 Siyah



311 Crom



310-1 Siyah



311 Crom



311



311-PV2



311-PV2



311SS



312



313



316



317-V1



317V1.ss



317-V2

317V2.ss

317-V3

318

318V3

318-V1

318-V2



318V2.ss

319

319 Crom

320 Krom

320

324-v1

329-V1.ss



324-V2

324-V2.ss

324-V3

329-V1

329-V1.ss

329-V2

329V2.ss



329-V3

330

330-Ayaklar

331-V5

331-V1

331-V2



331-V6

332

333-  
Vidali

340-  
Vidali

341-  
Vidali

341

342



342-1

342SS

343

344

346-02

347

348



349

350-V1

350-V2

350-V3

351-V1

351-V2

351-V3



354

355

355-2

356SS

356-V1

356-V2

356-V3

356-V4





357



358



360-V1



360-V2



360-V2-1



360-V3



361-V1



362



370



370SS

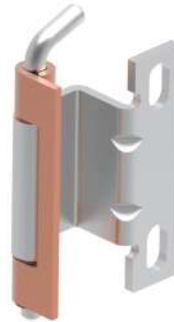

371-V1



371-V2

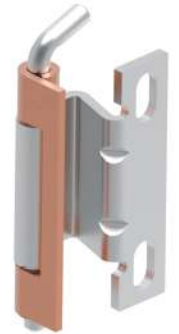

371-V3

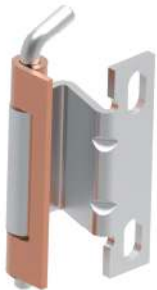

371-V4



372-V1



372-V2



372-V3



372-V4



400-1,2,3



401-403 2



402



402-1



402-2



402-3



402-5



402-6



402-7



402-8



402-9



472



550



551



552-V1



552-V2



601



602



603



604



605



606



607



608



609



610



611

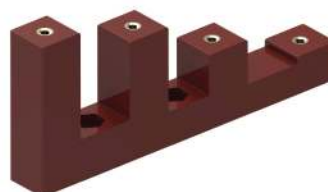

612



618



621



622



628



630 RESIM



631 RESIM



632 RESIM



633 RESIM



634



701-2



701-2F



701-3



701-4



701-5



701-V1



701-V2  
YENI



702



703



704,1



704,1



704-2



704-3



705



706



706-115





706-122 Tipa

706-122.100

706-122

706-A

707

707TB  
7035



708

709-MB

709-M10

709-M12

712

716

717-V1



717-V2

718

718-V2

719

719-2

720

721-V1



721-V2

721-V3

721-V4

721-V5

721-V6

721-V7

721-V8

721-V9

721-V10



724



726



728



730-V1



730-V2



760



770



802



900



901



902



903



904



905



906-V1



906-V2



910



911



912



913



914



920



921



922



1001



1030





5377428



Bague arret



Barel DB



Barel Kare



Barel Uçgen



Barel 1333



Joint Plat



Joints



Cekmece-Kategori



Circlip  
internal



Joint Torique27  
1000



Kirmizi izolatorler



ist

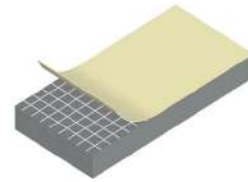

Joint Plat  
simple face



4615506





**Be our distinguished guests and let YATO witness your *success!***

YATO TOOLS CO.,LTD.

YATO originated in Europe as a brand for top-grade tools developed by TOYA Corporation.

[www.yato.com](http://www.yato.com)



**Cordless drill / driver**



$L_w = 71.0 \pm 3.0$  dB;  
 $L_p = 82.0 \pm 3.0$  dB;  
 $a_s = 3.0 \pm 1.5$  m/s<sup>2</sup>

**18V**  
**Li-Ion**

YATOO	V	Cap.
YT-82780	18	5

**Cordless impact drill / driver**



$L_w = 82.0 \pm 3.0$  dB;  
 $L_p = 93.0 \pm 3.0$  dB;  
 $a_s = 3.0 \pm 1.5 / 9.99 \pm 1.5$  m/s<sup>2</sup>

**18V**  
**Li-Ion**

YATOO	V	Cap.
YT-82786	18	5

**Cordless drill / driver**



$L_w = 71.0 \pm 3.0$  dB;  
 $L_p = 82.0 \pm 3.0$  dB;  
 $a_s = 3.0 \pm 1.5$  m/s<sup>2</sup>

**18V**  
**Li-Ion**

YATOO	V	Cap.
YT-82782	18	4

**Cordless impact drill / driver**



$L_w = 82.0 \pm 3.0$  dB;  
 $L_p = 93.0 \pm 3.0$  dB;  
 $a_s = 3.0 \pm 1.5 / 9.99 \pm 1.5$  m/s<sup>2</sup>

**18V**  
**Li-Ion**

YATOO	V	Cap.
YT-82788	18	4

**Brushless cordless drill / driver**



$L_w = 74.0 \pm 3.0$  dB;  
 $L_p = 85.0 \pm 3.0$  dB;  
 $a_s = 3.0 \pm 1.5$  m/s<sup>2</sup>

**18V**  
**Li-Ion**

YATOO	V	Cap.
YT-82794	18	4

**Cordless impact screwdriver**



$L_w = 82.0 \pm 3.0$  dB;  
 $L_p = 93.0 \pm 3.0$  dB;  
 $a_s = 8.15 \pm 1.5$  m/s<sup>2</sup>

**18V**  
**Li-Ion**

YATOO	V	Cap.
YT-82800	18	5

**Brushless cordless drill / driver**



$L_w = 73.0 \pm 3.0$  dB;  
 $L_p = 84.0 \pm 3.0$  dB;  
 $a_s = 3.0 \pm 1.5 / 9.96 \pm 1.5$  m/s<sup>2</sup>

**18V**  
**Li-Ion**

YATOO	V	Cap.
YT-82796	18	4

**Cordless impact wrench**



$L_w = 84.0 \pm 3.0$  dB;  
 $L_p = 95.0 \pm 3.0$  dB;  
 $a_s = 9.09 \pm 1.5$  m/s<sup>2</sup>

**18V**  
**Li-Ion**

YATOO	V	Cap.
YT-82804	18	4

**Cordless circular saw**



**18V**  
**Li-Ion**

$L_w = 95.0 \pm 3.0$  dB;  
 $L_p = 96.0 \pm 3.0$  dB;  
 $a_s = 5.33 \pm 1.5$  m/s<sup>2</sup>

YATOO	V	Cap.
YT-82810	18	2

**Cordless saber saw**



**18V**  
**Li-Ion**

$L_w = 81.0 \pm 3.0$  dB;  
 $L_p = 92.0 \pm 3.0$  dB;  
 $a_s = 7.5 \pm 1.5 / 8.3 \pm 1.5$  m/s<sup>2</sup>

YATOO	V	Cap.
YT-82814	18	4

**Cordless jig saw**



**18V**  
**Li-Ion**

$L_w = 76.0 \pm 3.0$  dB;  
 $L_p = 77.0 \pm 3.0$  dB;  
 $a_s = 6.28 \pm 1.5 / 5.78 \pm 1.5$  m/s<sup>2</sup>

YATOO	V	Cap.
YT-82822	18	4

**Cordless angle saw**



**18V**  
**Li-Ion**

$L_w = 88.0 \pm 3.0$  dB;  
 $L_p = 95.0 \pm 3.0$  dB;  
 $a_s = 4.9 \pm 1.5$  m/s<sup>2</sup>

YATOO	V	Cap.
YT-82826	18	4

**Cordless angle grinder**



**18V**  
**Li-Ion**

$L_w = 99.0 \pm 3.0$  dB;  
 $L_p = 90.0 \pm 3.0$  dB;  
 $a_s = 4.9 \pm 1.5$  m/s<sup>2</sup>

YATOO	V	Cap.
YT-82825	18	4

**Cordless rotary hammer**



**18V**  
**Li-Ion**

YATOO	V	Cap.
YT-82770	18	5

**Cordless multi-purpose oscillating tool**



**18V**  
**Li-Ion**

YATOO	V	Cap.
YT-82818	18	4

**Cordless hedge trimmer**



**18V**  
**Li-Ion**

$L_w = 77.3 \pm 3.0$  dB;  
 $L_p = 86.1 \pm 3.0$  dB;  
 $a_s = 1.5 \pm 1.5$  m/s<sup>2</sup>

YATOO	V	Cap.
YT-82834	18	2

**Cordless grass trimmer**



**18V**  
**Li-Ion**

$L_w = 80.4 \pm 3.0$  dB;  
 $L_p = 83.0 \pm 3.0$  dB;  
 $a_s = 1.5 \pm 1.5$  m/s<sup>2</sup>

YATOO	V	Cap.
YT-82830	18	2

**Cordless hedge trimmer**



**18V**  
**Li-Ion**

$L_w = 80.0 \pm 3.0$  dB;  
 $L_p = 87.5 \pm 3.0$  dB;  
 $a_s = 1.5 \pm 1.5$  m/s<sup>2</sup>

YATOO	V	Cap.
YT-82832	18	2

**Cordless telescopic pole saw**



**18V**  
**Li-Ion**

$L_w = 82.3 \pm 3.0$  dB;  
 $L_p = 82.2 \pm 3.0$  dB;  
 $a_s = 1.5 \pm 1.5$  m/s<sup>2</sup>

YATOO	V	Cap.
YT-82836	18	2

**Battery**



**18V**  
**Li-Ion**

YATOO	V	capacity (Ah)	charging time (h)
YT-82842	18	2.0	1.0
YT-82843	18	3.0	1.5
YT-82844	18	4.0	2.0

**Angle grinder**



**Brushless angle grinder**



**Angle grinder**



**Angle grinder**



<p><b>Angle grinder</b></p> <p>230V-50Hz 850 W 125mm 12000 RPM M14</p> 	<p><b>Angle grinder</b></p> <p>230V-50Hz 1100 W 125mm 12000 RPM M14</p> 	<p><b>Angle grinder</b></p> <p>230V-50Hz 2100 W 6500 RPM 230mm M14</p> 	<p><b>Angle grinder</b></p> <p>230V-50Hz 2800 W 230mm 6600 RPM M14</p> 
<p>YATOO W YT-82097 850 6</p>	<p>YATOO W YT-82100 1100 6</p>	<p>YATOO W YT-82103 2100 2</p>	<p>YATOO W YT-82110 2800 2</p>
<p><b>Multi-purpose oscillating tool</b></p> <p>230V-50Hz 500 W 10mm 25mm</p>  <p>CUTTING, CARVING, SANDING, SCRAPING</p>	<p><b>Electric drill</b></p> <p>230V-50Hz 500 W 0-4000 RPM 10mm 13mm 25mm</p> 	<p><b>Electric drill</b></p> <p>230V-50Hz 710 W 0-2500 RPM 13mm 25mm</p> 	<p><b>Rotary hammer</b></p> <p>620 W 230-240V 50Hz SDS PLUS 2.3J</p> 
<p>YATOO W YT-82223 500 4</p>	<p>YATOO W YT-82049 500 10</p>	<p>YATOO W YT-82052 710 10</p>	<p>YATOO W YT-82115 620 3</p>
<p><b>Impact Drill</b></p> <p>710 W 0-2800 RPM 13mm 25mm</p> 	<p><b>Impact Drill</b></p> <p>230-240V 50Hz 810 W 0-2800 RPM 13mm 25mm 3m</p> 	<p><b>Impact Drill</b></p> <p>230-240V 50Hz 850 W 0-2800 RPM 13mm 25mm 3m</p> 	<p><b>Rotary hammer</b></p> <p>850 W 230-240V 50Hz SDS PLUS 3.3J</p> 
<p>YATOO W YT-82034Y 710 6</p>	<p>YATOO W YT-82036Y 810 10</p>	<p>YATOO W YT-82037Y 850 5</p>	<p>YATOO W YT-82122 850 3</p>
<p><b>Impact Drill</b></p> <p>1050 W 0-2800 RPM 13mm 25mm</p> 	<p><b>Rotary hammer</b></p> <p>230V-50Hz 850 W 0-1100 RPM 0-4000 RPM SDS PLUS 3J</p> 	<p><b>Rotary hammer</b></p> <p>230V-50Hz 1250 W 300 RPM 4J SDS PLUS</p> 	<p><b>Rotary hammer</b></p> <p>230V-50Hz 1500 W 300 RPM 5J SDS PLUS</p> 
<p>YATOO W YT-82044Y 1050 5</p>	<p>YATOO W YT-82120 850 2</p>	<p>YATOO W YT-82125 1250 2</p>	<p>YATOO W YT-82127 1500 2</p>
<p><b>Rotary hammer</b></p> <p>1050 W 0-400 RPM 9J SDS MAX</p> 	<p><b>Rotary hammer</b></p> <p>230V-50Hz 1100 W SDS PLUS</p> 	<p><b>Rotary hammer</b></p> <p>230V-50Hz 1600 W 1100 RPM 4J SDS MAX</p> 	<p><b>Demolition hammer</b></p> <p>1150 W 230-240V 50Hz T 4800 RPM 15J SDS MAX 2.5mm 4.8 kg</p> 
<p>YATOO W YT-82130 1050 2</p>	<p>YATOO W YT-82123 1100 3</p>	<p>YATOO W YT-82135 1600 2</p>	<p>YATOO W YT-82133 1150 2</p>



<p><b>Diamond core drill</b></p> <p>230V-50Hz 2200 W</p>  <p><b>YATO</b> W YT-61980 2200 1</p>	<p><b>Demolition hammer</b></p> <p>230V-50Hz 1500 W 65J SDS HEX</p>  <p><b>YATO</b> W YT-82001 1500 1</p>	<p><b>Concrete vibrator</b></p> <p>1300 W 230V-50Hz</p>  <p><b>YATO</b> W YT-82600 1300 5</p>	<p><b>Concrete vibrator</b></p> <p>2300 W 230V-50Hz</p>  <p><b>YATO</b> W YT-82601 2300 4</p>
<p><b>Drywall sander</b></p> <p>230V-50Hz 1300 W 500mm 150mm</p>  <p><b>YATO</b> W YT-82340 1220 2</p>	<p><b>Finishing sander</b></p> <p>230V-50Hz 260 W 360mm</p>  <p><b>YATO</b> W YT-82230 260 4</p>	<p><b>Electric planer</b></p> <p>230V-50Hz 1050 W 0-10000 RPM 82 mm</p>  <p><b>YATO</b> W YT-82140 1050 4</p>	<p><b>Planer</b></p> <p>810 W 11 mm 230V-50Hz 82 mm 1600 RPM</p>  <p><b>YATO</b> W YT-82141 810 6</p>
<p><b>Jig saw</b></p> <p>230V-50Hz 550 W 300-2000 RPM 150mm</p>  <p><b>YATO</b> W YT-82270 550 5</p>	<p><b>Jig saw</b></p> <p>230V-50Hz 750 W 300-2000 RPM 150mm</p>  <p><b>YATO</b> W YT-82271 750 5</p>	<p><b>Jig saw</b></p> <p>230V-50Hz 750 W 300-2000 RPM 150mm</p>  <p><b>YATO</b> W YT-82272 750 5</p>	<p><b>Polisher</b></p> <p>1200 W 150-3000 RPM 5m M16</p>  <p><b>YATO</b> W YT-82195 1200 3</p>
<p><b>Circular saw</b></p> <p>230V-50Hz 1500 W 195mm 24T 500mm</p>  <p><b>YATO</b> W YT-82151 1500 2</p>	<p><b>Electric table saw</b></p> <p>1800 W 230V-50Hz 500 RPM 24T 140mm 140mm</p>  <p><b>YATO</b> W YT-82165 1800 1</p>	<p><b>Marble stone machine</b></p> <p>230V-50Hz 1300 W 140mm 115mm</p>  <p><b>YATO</b> W YT-82160 1300 4</p>	<p><b>Orbital polisher</b></p> <p>720 W 230V-50Hz 2300 RPM M8 5m 150mm x3</p>  <p><b>YATO</b> W YT-82200 720 4</p> <p>ADDITIONAL PARTS: POLISHING DISCS</p> 
<p><b>Cut off machine</b></p> <p>230V-50Hz 2450 W 115mm 500mm</p>  <p><b>YATO</b> W YT-82181 2450 1</p>	<p><b>Miter saw</b></p> <p>1800 W 230V-50Hz 500 RPM 24T 140mm</p>  <p><b>YATO</b> W YT-82173 1800 5</p>	<p><b>Blower</b></p> <p>600 W 100-240V 50/60Hz 4 m³/min 2m</p>  <p><b>YATO</b> W YT-85170 600 4</p>	<p><b>Reciprocating saw</b></p> <p>230V-50Hz 1200 W 300-2000 RPM 150mm QUICK RELEASE QUICK CHANGE</p>  <p><b>YATO</b> W YT-82280 1200 4</p>

Gasoline chainsaw	
9.9kW 1.2HP	25.4 cm
1.32m	0.050"
1.27m	0.98 l



YATO	
YT-84890	1

Gasoline chainsaw	
1.8kW 2.4HP	45.1 cm
1.32m	0.050"
1.47m	0.34 l



YATO	
YT-84891	1

Gasoline chainsaw	
2.1kW 2.8HP	51 cm
1.32m	0.050"
1.47m	0.34 l



YATO	
YT-84892	1

Brushcutter	
1.25kW 1.74kW	43 cm
1.4m	40 : 1



YATO	
YT-84955	1

Lawn mowers	
230V-50Hz	1300 W



YATO	
YT-85200	1

Lawn mowers	
230V-50Hz	1800 W



YATO	
YT-85205	1

Lawn mowers	
230V-50Hz	1800 W



YATO	
YT-85208	1

Gasoline backpack sprayer	
2.13kW 2.8kW	16 l



YATO	
YT-85140	1

Wet and dry vacuum cleaner	
230V-50Hz	1400 W



YATO	
YT-85706	1
YT-85707	1
YT-85710	1

Multi function wet and dry vacuum cleaner	
230V-50Hz	1600 W



YATO	
YT-85715	1

High pressure washer	
1400 W	10.5 MPa



YATO	
YT-85910	1

High pressure washer	
2000 W	15 MPa



YATO	
YT-85915	1

Gasoline water pump	
4.1 kW	18 l/min



YATO	
YT-85401	1
YT-85402	1
YT-85403	1

Gasoline generator	
2kVA	13.9 A



YATO	
YT-85451	1
YT-85453	1
YT-85460	1

Electric hoist	
230V-50Hz	500 kg



YATO	
YT-5901	2
YT-5902	2
YT-5904	2
YT-5905	2

Concrete vibrator	
4 kW	12.5 mm



YATO	
YT-84820	1

Submersible pump for dirty water and wastewater	
230V-50Hz	750 W



YATO	
YT-85350	1

Inverter welding machine	
220V-50Hz	160 A



YATO	
YT-81330	1
YT-81332	1

Traditional lubricated compressor	
200-500W	24 L



YATO	
YT-23239	1
YT-23235	1

Belt driven professional series for heavy-duty work	
200-500W	50 L



YATO	
YT-23237	1
YT-23240	1



 **ETS**

Accessoires YATOO

FIX  
**YATO**  <sup>®</sup>



**MANUFACTURER / PRODUCENT**

TOYA S.A.  
ul. Sołtysowicka 13-15  
51-168 Wrocław  
☎ (+48 71) 32 46 200  
fax: (+48 71) 32 46 370  
sales@yato.pl (sale)  
export@yato.pl (export)  
import@yato.pl (import)

TOYA ROMANIA S.A.,  
Sos. Odăi Nr. 109-123,  
Sector 1, București,  
☎ 0040 031 710 8692,  
office@yato.ro

YATO TOOLS(SHANGHAI)Co.,Ltd  
No.8 Lane 1300  
East KangQiao Road  
Shanghai 201315  
☎ (+86 21) 209 811 06  
fax: (+86 21) 209 811 08  
export@yato-sh.com  
website:www.yato.com

**Catalogue download-check**

<http://www.yatohandtools.com/download-5.html>



### Twist drill HSS

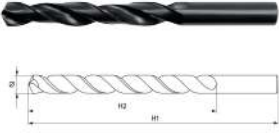

### Masonry drill bit



### Twist drill HSS-COBALT

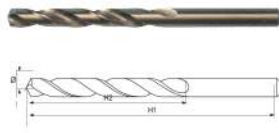

### Masonry drill bit X-TIP



### Point chisel SDS+



### Hollow drill set Bi-metal hole saw



### Metal cutting disc



### Inox cutting disc



### TCT circular saw blade for wood



### Twist drill HSS

YATO	∅ (mm)	H1 (mm)	H2 (mm)	R.P.M.max.	PCS packing
YT-4449	8.0	117	75	1000	10/40
YT-4453	10.0	133	87	800	10/40
YT-4458	13.0	151	101	600	10/40

### Masonry drill bit

YATO	∅ (mm)	H1 (mm)	H2 (mm)	PCS packing
YT-4364	6	150	100	100/400
YT-4375	10	120	80	75/300
YT-4385	16	180	120	25/100

### Twist drill HSS-COBALT

YATO	∅ (mm)	H1 (mm)	H2 (mm)	PCS packing
YT-4050	5.0	86	52	100/400
YT-4070	7.0	109	69	75/300
YT-4160	16.0	178	120	25/100

### Masonry drill bit X-TIP

YATO	∅ (mm)	H1 (mm)	H2 (mm)	PCS packing
YT-4206	8	210	140	10/150
YT-4211	10	300	220	10/100
YT-4228	22	600	490	5/20

### Point chisel SDS+

YATO	L (mm)	PCS
YT-4720	250	6/48
YT-4721	250	6/48
YT-4722	250	6/48
YT-4723	250	6/48

### Hollow drill set & Bi-metal hole saw

YATO	∅ (mm)	TCT	thread	PCS
YT-4401	80	8		20
YT-4403	80	8		20
YT-3313	32		5/8" (16 mm)	25/100

### Metal cutting disc

YATO	∅A (mm)	∅B (mm)	R.P.M.max.	D (mm)	PCS
YT-6110	125	22	12200	3.2	25/200
YT-6111	180	22	8600	3.2	25/100
YT-6112	230	22	6500	3.2	25/50

### Inox cutting disc

YATO	∅A (mm)	∅B (mm)	R.P.M.max.	D (mm)	PCS
YT-6103	125	22	12200	1.2	25/200
YT-6105	180	22	8600	1.5	25/50
YT-6107	230	22	6500	2.0	25/50

### TCT circular saw blade for wood / aluminum

YATO	∅ (mm)	d (mm)	R.P.M.max.	D (mm)	thickness of blade	T	PCS
YT-60634	190	20.0	7100	2.2	1.5	24	25/50
YT-60668	235	25.5	5800	2.5	1.8	24	25
YT-6091	200	30	8000	3.0	2.2	60	10/20
YT-6099	350	30	4500	3.2	2.5	100	10

### Twist drill set

10 PCS ∅ mm 1-10



YATO	∅ (mm)	PCS
YT-4461	1; 2; 3; 4; 5; 6; 7; 8; 9; 10	20/40

### Twist drill set

Co-HSS JRE ∅ mm 1-10 19 PCS DIN 338



YATO	∅ (mm)	PCS
YT-41604	1.0; 1.5; 2.0; 2.5; 3.0; 3.5; 4.0; 4.5; 5.0; 5.5; 6.0; 6.5; 7.0; 7.5; 8.0; 8.5; 9.0; 9.5; 10.0	15/30

### Twist drill set

25 PCS DIN 338 Co-HSS ∅ mm 1-13



YATO	∅ (mm)	PCS
YT-41605	1.0; 1.5; 2.0; 2.5; 3.0; 3.5; 4.0; 4.5; 5.0; 5.5; 6.0; 6.5; 7.0; 7.5; 8.0; 8.5; 9.0; 9.5; 10.0; 10.5; 11.0; 11.5; 12.0; 12.5; 13.0	10

### Electrician's hole saw kit

9 PCS Bi-METAL HSS M3 ALU/STL 4-8 TP 40mm



YATO	∅ (mm)	PCS
YT-3380	22; 29; 35; 44; 67; 73	8

### Router bit set

±0.01 mm 35 PCS



YATO	∅ (mm)	PCS
YT-6803		10

### Cup brush with shaft set

∅ 6 mm



YATO	∅ (mm)	R.P.M.max.	PCS
YT-4755	20	6000	12/60
	50	7500	
	50	4500	

### Cup brush

M4



YATO	∅ (mm)	R.P.M.max.	PCS
YT-4766	100	8500	4/32



Service tool cabinet with tools



YT-5531 YT-5532 YT-5533 YT-5534 YT-5535 YT-5536



YATO	size (mm)	lock	drawers
YT-55300	975x765x465	78	1

Sockets set

10 PCS 1/2" CrV S2



1/2": 10, 12, 13, 14, 15, 17, 19, 21, 22, 24 mm (L=76 mm); CrV 50BV30

YATO	lock	size (mm)	drawers
YT-38861	1300	10	

Sockets set

1/4" 23 PCS CrV S2



YATO	lock	size (mm)	drawers
YT-14421	114	1330	10

Tools sets

78 PCS 1/2" 1/4" CrV S2  
12.5 mm 8.3 mm S2  
72T



YATO	lock	size (mm)	drawers
YT-38911	1200	2	

Tool set

68 PCS 1/4" 1000 V CrV S2



YATO	lock	size (mm)	drawers
YT-39009	480	2	

Tool box with tools

63 PCS 1/2" 12.5 mm CrV S2  
72T



YATO	lock	size (mm)	drawers
YT-3895	475x230x365	1	

Cantilever tool box



YATO	lock	size (mm)	drawers
YT-0887	475x230x365	1	

Service tool cabinet with tools



YATO	size (mm)	drawers
YT-55280	905x685x455	3

Tool set

3/8" 19 PCS CrV S2

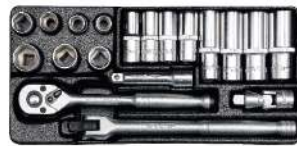

YATO	lock	size (mm)	drawers
YT-38841	35	230	8

Tool set

94 PCS 1/2" 1/4" CrV S2  
72T 10-30V



YATO	lock	size (mm)	drawers
YT-12661	900	2	

Tool set

215 PCS 1/2" 3/8" 1/4" CrV S2  
72T 10-30V



YATO	lock	size (mm)	drawers
YT-38841	9100	2	

Tool set

100 PCS CrV S16



YATO	lock	size (mm)	drawers
YT-12685	1/2" (12.7mm) 1/4" (9.5mm)	2	

Tool box

PP



YATO	lock	size (mm)	drawers
YT-88880	350x190x140	1060	1
YT-88881	420x210x195	1380	1
YT-88882	475x230x210	1680	1

Roller trolley



YATO	lock	size (mm)	drawers
YT-09101	520X320X720	17.2	1

Insulated tools set



YATO	size (mm)	lock	drawers
YT-55305	958x766x465	71	1

Four wheel positioning toolbox set

53 PCS 1/2" 3/8" CrV S2  
72T 10-30V



YATO	lock	size (mm)	drawers
YT-38992	465x226x245	1	

Tool set

126 PCS 1/2" 3/8" CrV S2  
72T 10-30V



YATO	lock	size (mm)	drawers
YT-38575	900	2	

Tool set

68 PCS 1/4" CrV SK2 S2  
72T 10-30V



YATO	lock	size (mm)	drawers
YT-39004	480	2	

Pull rod type safety box



- strong body, high quality material
- anti-shock lock catch
- waterproof air permeability valve
- 1pcs
- customized inner sponge

YATO	lock	size (mm)	drawers
YT-08905	559x351x229	1/2	

Tool bag



YATO	lock	size (mm)	drawers
YT-74371	305x190x220	390	6



**Ball pein hammer**      **Claw hammer**      **Machinist hammer**      **Dead blow mallet**

**Ball pein hammer**



- forged carbon steel head, hardened and tempered
- hickory handle

YATO	LB (oz)	L (mm)	A (mm)	H (mm)
YT-4519	0.5(8oz)	295	26	80

**Claw hammer**



- forged carbon steel head, hardened and tempered
- hickory handle

YATO	m (kg/oz)	L (mm)	A (mm)	H (mm)
YT-4523	2.25(8oz)	290	26	110
YT-4524	3.70(13oz)	310	32	120
YT-4525	4.50(16oz)	335	30	135
YT-4526	5.70(20oz)	329	34	135
YT-4527	6.80(24oz)	383	34	140

**Machinist hammer**



Safety protection steel ring

High quality wooden handle

Forged carbon steel head hardened and tempered

YATO	m (g)	L (mm)	A (mm)	H (mm)
YT-4501	100	260	15	82
YT-4506	600	330	29	122
YT-4510	2000	400	47	155

**Dead blow mallet**



PU

- neon black

YATO	m(g)	L(mm)	Ø (mm)
YT-4620	740	300	44.5
YT-4622	900	336	53.5
YT-4623	1300	350	59.0

**Combination spanner set**



12 PCS    DIN 3113    CrV    AS-DRIVE

8, 9, 10, 11, 12, 13, 14, 15, 17, 19, 22, 24 mm

YATO	2500
YT-0362	6

**Combination spanner set**



17 PCS    DIN 3113    CrV    AS-DRIVE

8, 9, 10, 11, 12, 13, 14, 15, 16, 17, 18, 19, 22, 24, 27, 30, 32 mm

YATO	3650
YT-0363	3

**Ratchet combination wrench set**



7 PCS    CrV    7ZT

AS-DRIVE

10, 12, 13, 14, 15, 17, 19 mm

YATO	10/20
YT-0208	6

**Ratchet combination wrench set**



7 PCS    CrV    7ZT

AS-DRIVE

10, 12, 13, 14, 15, 17, 19 mm

YATO	1180
YT-16966	6

**Hex key**

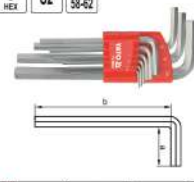

9 PCS    HEX    S2    HRC 58-62

YATO	2500
YT-58821	6

**Hex key**



9 PCS    HEX    S2    HRC 58-62

YATO	3650
YT-58825	6

**T-handle hex key set**



HEX    S2    HRC 58-62

YATO	10/20
YT-05583	6

**T-handle hex key with ball set**



HEX    S2    HRC 58-62

YATO	1180
YT-05597	6

**Screwdriver set**



15 PCS    S2    HRC 58

YATO	612
YT-25980	6

**Screwdriver set**



15 PCS    S2    HRC 58

YATO	624
YT-25981	6

**Screwdriver set**



2 PCS    S2    HRC 58

- PP+TPR 3 colour handle
- satin finish, sanded tip
- the head can use for striking

YATO	6/36
YT-25998	6

**Screwdriver**



S2

- PP+TPR 3 colour handle
- satin finish, sanded tip

YATO	size	L (mm)	shaft (mm)
YT-25908	5	100	5
YT-25912	6	150	6
YT-25915	8	200	8
YT-25924	PH1	100	5
YT-25930	PH2	150	6
YT-25934	PH3	200	8

**Quick release ratchet handle**



DIN 3122    QUICK RELEASE    CrV    1140

YATO	size	L (mm)	PCS packing
YT-07291	1/4"	155	12
YT-07292	3/8"	185	6
YT-07293	1/2"	255	6

**Telescopic quick release ratchet handle**



1/4" 7ZT    QUICK RELEASE    CrV    6135

3/8" 1/2"

- minimum operation angle 5°
- quick release
- extension bar increase the torque

YATO	size	L (mm)	PCS packing
YT-0297	1/4"	150-200	12
YT-0298	3/8"	215-315	6
YT-0299	1/2"	305-445	6

**Adjustable wrench**



DIN 3117    CrV

YATO	L (mm)	PCS packing
YT-2170	6" (150mm)	24
YT-2171	8" (200mm)	30
YT-2172	10" (250mm)	34
YT-2173	12" (300mm)	41

**Crow bar**



Mn 65

YATO	L (mm)	A (mm)	B (mm)	C (mm)
YT-46831	400	25	16	40
YT-46832	600	28	20	40
YT-46833	800	28	22	40
YT-46834	1000	28	22	40
YT-46835	1200	39	25	45
YT-46836	1500	39	25	45

**Ratchet screwdriver set**



42 PCS    1/4"    CrV    AS-DRIVE

YATO	1100
YT-2806	12

**Taps and dies set**



56 PCS    HSS    DIN 9132

YATO	size	2
YT-2979	M3, M4, M5, M6, M8, M10, M12, M14, M16, M18, M20	2

**Impact bit socket set**



1/2"    CrMo    HRC 34

T30, T40, T45, T50, T55, T60, TORX T70, T80

YATO	900
YT-1065	15

**Cross rim wrench**



CrV

YATO	size	10
YT-0800	17x19x21x22	10
YT-0801	17x19x21x1/2"	10
YT-0802	24x27x32x3/4"	3
YT-08002	17x19x21x23	10



### Combination pliers

HRC 44-50  
HRC 58-62  
CrV 55  
DIN 5748

HALF DOUBLE BLASTER

YATO	size	
YT-1940	6" (160mm)	6/60
YT-1941	7" (180mm)	6/60
YT-1942	8" (200mm)	6/60

### Diagonal side cutting pliers

HRC 44-50  
HRC 58-62  
CrV 55  
DIN 5748

HALF DOUBLE BLASTER

YATO	size	
YT-1947	6" (160mm)	6/60
YT-1948	7.5" (190mm)	6/60

### Bent nose pliers

HRC 44-50  
HRC 58-62  
CrV 55  
DIN 5748

HALF DOUBLE BLASTER

YATO	size	
YT-1945	6" (160mm)	6/60
YT-1946	8" (200mm)	6/60

### Long nose pliers

HRC 44-50  
HRC 58-62  
CrV 55  
DIN 5748

HALF DOUBLE BLASTER

YATO	size	
YT-1943	6" (160mm)	6/60
YT-1944	8" (200mm)	6/60

### Ring pliers

160 mm  
10-50

SLIDING GARD

YATO	L (mm)	
YT-2130	160	20/60

### Side cutting pliers

HRC 56-62  
HRC 60-62  
CrV 60

SLIDING GARD

- body: HRC 43-48
- cutter: HRC 56-62
- application: cable cutting

YATO	size	plastic max (mm)	
YT-1950	5" (125mm)	3	6/20
YT-1951	6" (160mm)	5	6/20
YT-1952	7" (180mm)	6	6/60

### Water pump pliers

YATO	L (mm)	
YT-2070	250	6/24

### Locking pliers

CrMo

- European type lock
- curved jaw with wire cutter nickel plated
- double dipped handle for small handle

YATO	size	
YT-2449	5" (125mm)	6/24
YT-2450	7" (180mm)	6/24
YT-2451	10" (250mm)	6/24

### Automatic wire stripper

175 mm  
65Ma  
HRC35

- material: 65Ma
- widely used for cutting, stripping

YATO	L (mm)	stripping range	
YT-2268	175	5-25mm	10/60

### Spring clamp

YATO	A (mm)	B (mm)	C (mm)	
YT-64270	100	44	42	24/240
YT-64271	150	68	55	12/120
YT-64272	200	91	79	10/100

### Carpenter's pliers

DIN 5748  
CrV  
HRC 55-60

YATO	L (mm)	cutting steel dia (mm)	
YT-2050	150	1.5	6/60
YT-2051	175	1.8	6/60
YT-2052	200	2.0	6/48

### End cutting pliers

DIN 5748  
CrV  
HRC 55-60

YATO	L (mm)	cutting steel dia (mm)	
YT-2062	150	1.2	6/60
YT-2063	175	1.5	6/48
YT-2064	200	1.8	6/48

### Bolt cutter

HRC 56-61  
CrMo

YATO	size	max. Ø (mm)	
YT-1843	12"	4	20
YT-1844	14"	5	10
YT-1845	18"	6	10
YT-1846	24"	8	6
YT-1847	30"	10	4
YT-1848	36"	12	3
YT-1849	42"	14	2

### Hydraulic pliers

YATO	L (mm)	size (mm)	pressure (T)	stripping range (mm)	
YT-22680	410	10-20	8	10-40	10-20
YT-22681	470	10-24	12	10-180	10-24
YT-22682	470	10-30	18-20	10-240	10-30

### Cable cutter

STEEL STAL

YATO	L (mm)	stripping range (mm)	
YT-18611	780	250	10
YT-18612	770	500	5

### Hydraulic cutter

YATO	L (mm)	size (mm)	pressure (T)	cutting dia (mm)	
YT-22870	430	Ø 4-12	6	Ø 5-12	15
YT-22871	430	Ø 4-16	8	Ø 5-16	15
YT-22872	515	Ø 4-20	10	Ø 5-20	3

### Pipe wrench

CrMo

- CoMo hook jaws hardness HRC58-60
- Casting steel handle

YATO	L	size	
YT-24869	6" (150mm)	Ø 75	6/30
YT-2487	8" (200mm)	1"	6/30
YT-2488	10" (250mm)	1.5"	6/18
YT-2489	12" (300mm)	2"	6/12
YT-2490	14" (350mm)	2"	2/10
YT-2491	18" (450mm)	2.5"	3/6
YT-2492	24" (600mm)	3"	2/4
YT-2493	36" (900mm)	6"	1/1
YT-2494	48" (1200mm)	6"	1/1
YT-2495	60" (1500mm)	6"	1/1

### Cable cutter

160 mm  
210 mm  
240 mm  
HRC 55-60

YATO	L (mm)	max. Ø (mm)	
YT-1966	160	6	6/60
YT-1967	210	7	6/60
YT-1968	240	8	6/48

### Tin snips

SS5C  
HRC 55-60

- SS5C drop forged
- blade of head: high frequency hardening

YATO	L (mm)	cutting length (mm)	upper	lower	cutting capacities (mm)	
YT-1971	200	40	1.5	1.0	0.6	6/36
YT-1972	260	53	1.8	1.2	0.8	6/36
YT-1973	310	62	2.0	1.4	0.8	6/12

### PVC pipe cutter

AUTOMATIC  
max Ø 42 mm  
HRC 55-60

YATO	max (mm)	
YT-2231	42	390 6/48

### Cutter knife

SK5  
TRY ME DOUBLE BLISTER

YATO	size (mm)	
YT-7520	61x33x0.5	165 6/48

### Utility knife

SK2  
ABS TPR  
LOCK

YATO	size (mm)	
YT-7506	9x0.4	24/240
YT-7507	18x0.5	12/144

### Multi knife

SHARPENED STEEL BLADE  
AI

YATO	L (mm)	
YT-76040	95	12/120

### Folding knife

SHARPENED STEEL BLADE  
AI

YATO	L (mm)	
YT-76052	202	12/120

**Pneumatic wrench**

1"	1/2"	560 U/min	FINE LEAD HAMMER TYPE
0.63 MPa	4000 RPM	2600 Nm	CE

• application: automotive service stations, trucks  
 • long anvil, square drive 1", idle speed 4,000 min-1  
 • setting with 3 forward and 3 reverse speed  
 • max torque: 2600Nm

<b>YATO</b>	Nm		
YT-0960	2600	13000	2

**Twin hammer impact wrench**

3/8"	142 U/min	0.63 MPa	400 Nm	RED BODY
1/4"	TWIN HAMMER TYPE	10000 RPM	CE	

• square driver 3/8", idle speed 1420 min-1  
 • twin hammer  
 • max. torque: 400 Nm

<b>YATO</b>	Nm		
YT-09501	400	1750	10

**Twin hammer impact wrench**

1/2"	119 U/min	0.63 MPa	550 Nm
1/4"	TWIN HAMMER TYPE	7500 RPM	CE

• square driver 1/2", idle speed 1190 min-1  
 • twin hammer  
 • max. torque: 550 Nm

<b>YATO</b>	Nm		
YT-09511	550	2680	8

**Twin hammer impact wrench**

3/4"	660 U/min	0.62 MPa	1300 Nm
3/8"	TWIN HAMMER TYPE	10000 RPM	CE

• square driver 3/4", idle speed 6600 min-1  
 • dyna-pact type  
 • max. torque: 1300 Nm

<b>YATO</b>	Nm		
YT-09564	1300	4500	4

**Ratchet air wrench**

1/2"	12.5 U/min	150 RPM	360° TORQUE ADJUSTMENT	ULTRA LIGHT
80 Nm	142 U/min	1.4kg	STANDARD	
0.63 MPa				

<b>YATO</b>	Nm		
YT-09803	80	1350	12

**Air grinder**

0.63 MPa	113 U/min	3500 RPM	6 mm
360° TORQUE ADJUSTMENT	0.33kg		

<b>YATO</b>			
YT-09633	350	40	

**Air drill**

0.63 MPa	141 U/min	20000 RPM	ULTRA LIGHT
0.66 MPa			

<b>YATO</b>			
YT-09695	680	20	

**Angle polisher**

0.63 MPa	84 U/min	1/4"	11000 RPM	CE
150				

<b>YATO</b>	size		
YT-09739	6"	960	10

**Air hammer**

0.63 MPa	113 U/min	4500 RPM	CE
----------	-----------	----------	----

<b>YATO</b>			
YT-09904	1060	10	

**Gun suitable for sand-blasting**

1.01 MPa	160 U/min	AI	0.80 MPa
----------	-----------	----	----------

<b>YATO</b>			
YT-2376	20		

**Pneumatic stitching machine**

0.7 MPa	1.8mm	STANDARD
---------	-------	----------

$L_s = 88 \pm 2.5$  dB;  
 $L_w = 98 \pm 2.5$  dB;  
 $a_s = 3.5 \pm 1.5$  m/s<sup>2</sup>

<b>YATO</b>			
YT-09201	10		

**Pneumatic stitching machine**

0.8 MPa	150mm	STANDARD
---------	-------	----------

$L_s = 87.8 \pm 2.5$  dB;  
 $L_w = 100.8 \pm 2.5$  dB;  
 $a_s = 2.91 \pm 1.5$  m/s<sup>2</sup>

<b>YATO</b>			
YT-09203	10		

**Air duster gun**

0.8 MPa	PP	SHARK NOZZLE
---------	----	--------------

<b>YATO</b>			
YT-23731	20/40		

**Pneumatic hose reel**

15m	2.0 MPa	PVC
-----	---------	-----

<b>YATO</b>	size		
YT-24240	10MMX15M	2	

**Cable reel**

16A	230V	IP44	162.3 RPM	SOFT START
-----	------	------	-----------	------------

•  $P_{max}$  1200W coiled  
 max 1200W unwinding  
 •  $P_{max}$  3600W uncoiled  
 max 3600W rewinding

<b>YATO</b>	L (m)		
YT-8106	30	1	
YT-8107	40	1	
YT-8108	50	1	

**Workshop creeper**

100 cm
--------

<b>YATO</b>			
YT-0880	6	1	

**Hydraulic floor jack**

2t	CE
----	----

• hydraulic, max capacity: 2t, 365°  
 • rotating handle, min height: 68mm, max height: 359mm

<b>YATO</b>	T		
YT-1720	2	1	

**Swivel base bench vice**

15 kg
-------

• anvil and changeable jaws made of hardened steel

<b>YATO</b>	force pressure(KN)		
YT-6503	15	15	1

**Lever action grease gun with rigid spout**

AI	400 cm <sup>3</sup>	P <sub>max</sub> 70 MPa	P 31 MPa
----	---------------------	-------------------------	----------

<b>YATO</b>	size		
YT-0705	400cc	1200	20

**Torque wrench**

1"	CVT 916
----	---------

<b>YATO</b>	O	Nm	L(mm)	
YT-07407	1" (25.4mm)	150-800	1240	2
YT-07408	1" (25.4mm)	200-1000	1240	2
YT-0756	1" (25.4mm)	300-1500	1850	2

**Digital multimeter**

U 0-600V	U 0-600V	I 0-600mA
R 0-200MΩ	T 200-1000°C	CE

• 1/2 digits LCD display: 1999 counts;  
 • display backlight function  
 • overload protection  
 • maximum value hold mode  
 • low battery indication  
 • automatic zeroing function

<b>YATO</b>	L(mm)		
YT-73091	230x79x32	220	20

**Digital caliper**

RANGE 0-150 mm	SCALE 0.01 mm	BATTERY SR44 1.55V	STAINLESS STEEL
----------------	---------------	--------------------	-----------------

<b>YATO</b>			
YT-7205	170	10/50	

**Measuring tape**

GRADE II	2m	3m	5m	5m	8m	10m
----------	----	----	----	----	----	-----

<b>YATO</b>	size (m)	L (mm)	
YT-7149	2	16	12/144
YT-7150	3	16	12/144
YT-7151	5	19	12/96
YT-7152	5	25	12/96
YT-7153	8	25	6/48
YT-7154	10	25	6/48

**Hand saw for wood**

18" 457mm	ZT	CE
-----------	----	----

<b>YATO</b>	L (mm)		
YT-3101	400	12/48	
YT-3102	450	10/40	
YT-3103	500	10/40	



### By-pass pruner



<b>YATO</b>	L (mm)	
YT-8845	200	12/72

### Multifunction sprinkling gun



<b>YATO</b>		
YT-8963		12/48

### Basic hose set with straight nozzle



<b>YATO</b>		
YT-99831		48

### Gel knee pads



<b>YATO</b>		
YT-7461	530	12

• 600D oxford fabric, EVA, GEL

### Disposable dust masks



<b>YATO</b>		
YT-7487	10	25/100

### Disposable dust masks with valve



<b>YATO</b>		
YT-74954	15	50/500

### Working gloves



• Nitrile polyurethane palm coating  
• 13 gauge black seamless nylon liner, colour of cuff: red

<b>YATO</b>	size	
YT-7473	10"	50/100

### Working gloves



• 10 gauge cotton / polyester liner  
• nitrile latex palm coated

<b>YATO</b>	size	
YT-7471	10"	12/120

### Safety glasses



• TYPE #2769 EN 166:2001 F

<b>YATO</b>		
YT-7380	20/200	

### Safety glasses



• TYPE 91977 EN 166:2001 F

<b>YATO</b>		
YT-7363		12/240

### Safety helmet



<b>YATO</b>	color	
YT-7386	white	42
YT-7387	red	42
YT-7388	blue	42
YT-7389	yellow	42
YT-7390	orange	42
YT-7391	green	42

### Auto-darkening welding helmet



<b>YATO</b>		
YT-73921		8

### Safety harness for working at height



<b>YATO</b>		
YT-74220		1

### Hearing protectors



• foam insert, free from noisy  
• noise rate: 39,4dB  
• adjustable head band

<b>YATO</b>		
YT-7463	150	20

### Safety vest



<b>YATO</b>	color	size	
YT-74665A	yellow	XL	8
YT-74661A	orange	XL	8

### Working jacket



<b>YATO</b>	size	
YT-8021	S	20
YT-8022	M	20
YT-8023	L	20
YT-8024	XL	20

### Hi-Vi working jacket & trousers



<b>YATO</b>	size	
YT-80426	M	20
YT-80427	L	20
YT-80428	XL	20
YT-80429	XXL	20

### Working overalls



<b>YATO</b>	size	
YT-8030	S	20
YT-8031	M	20
YT-8032	L	20
YT-8033	XL	20
YT-8034	XXL	20

### Low-cut safety shoes



<b>YATO</b>	size	
YT-80584	40	10
YT-80585	41	10
YT-80586	42	10
YT-80587	43	10
YT-80588	44	10
YT-80589	45	10
YT-80590	46	10

### Middle-cut safety shoes



<b>YATO</b>	size	
YT-80795	40	10
YT-80796	41	10
YT-80797	42	10
YT-80798	43	10
YT-80799	44	10
YT-80800	45	10
YT-80801	46	10



NOUS SOMMES PARTENAIRE ET DISTRIBUTEUR EXCLUSIF DE :





**FIXATION INDUSTRIELLE**

**France** : 75 , Rue de Fontenay 94300 Vincennes - France

Tél : +33 178541920 / Mobile : +33782724925 / Mail : [contact@ets-international.fr](mailto:contact@ets-international.fr)

**Tunisie** : 3 , Rue Salah Ibn Youssef , Magasin N:3 , Résidence Jughura 2046 Sidi Daoued

Tél : +216 71 777 370 - 71 777 842 / Fax : 71 777 344 / Mail : [contact@ets-tunisia.com](mailto:contact@ets-tunisia.com)

**Magazin Tunis** : 20 Rue Ahmed Tlil 1001 Tunis

Tél : +216 71 335 549 / Mail : [contact@ets-tunisia.com](mailto:contact@ets-tunisia.com)